

Data Sheet



Article number: 0111015

Description: Retaining ring G 5

Measures

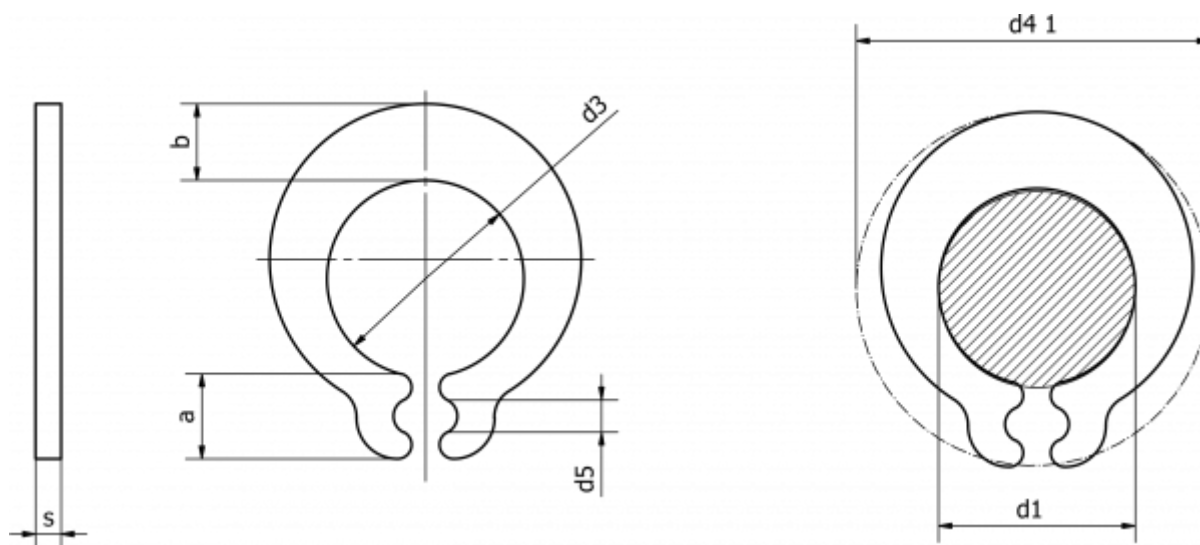

a max	= 2.9	n abl x 1000	= 100
b	= 2.2	s	= 0.80
d1	= 5.0	tol	= 0.075
d3	= 4.75	Tong	= ZGG-1
d4 1	= 11.0	Weight kg/1000	= 0.200
d5 min	= 1.3		
Description	= G 5,0		
Holding force N	= 130		